

10 GbE IP CONVERTER  
**USF-10IP**  
**USF-10IPSDI6-FS**  
**USF-10IPSDI12-FS**

Video over IP module for Universal System Frame USF-212S/105S.  
Dual 10 GbE (SFP+) module that converts input data between IP formats  
and between IP and SDI.  
Compatible with 4K (2SI/SQD) and multi-format\* input and output.

\* For details, contact your FOR-A dealer.

**Approaches to video over IP**

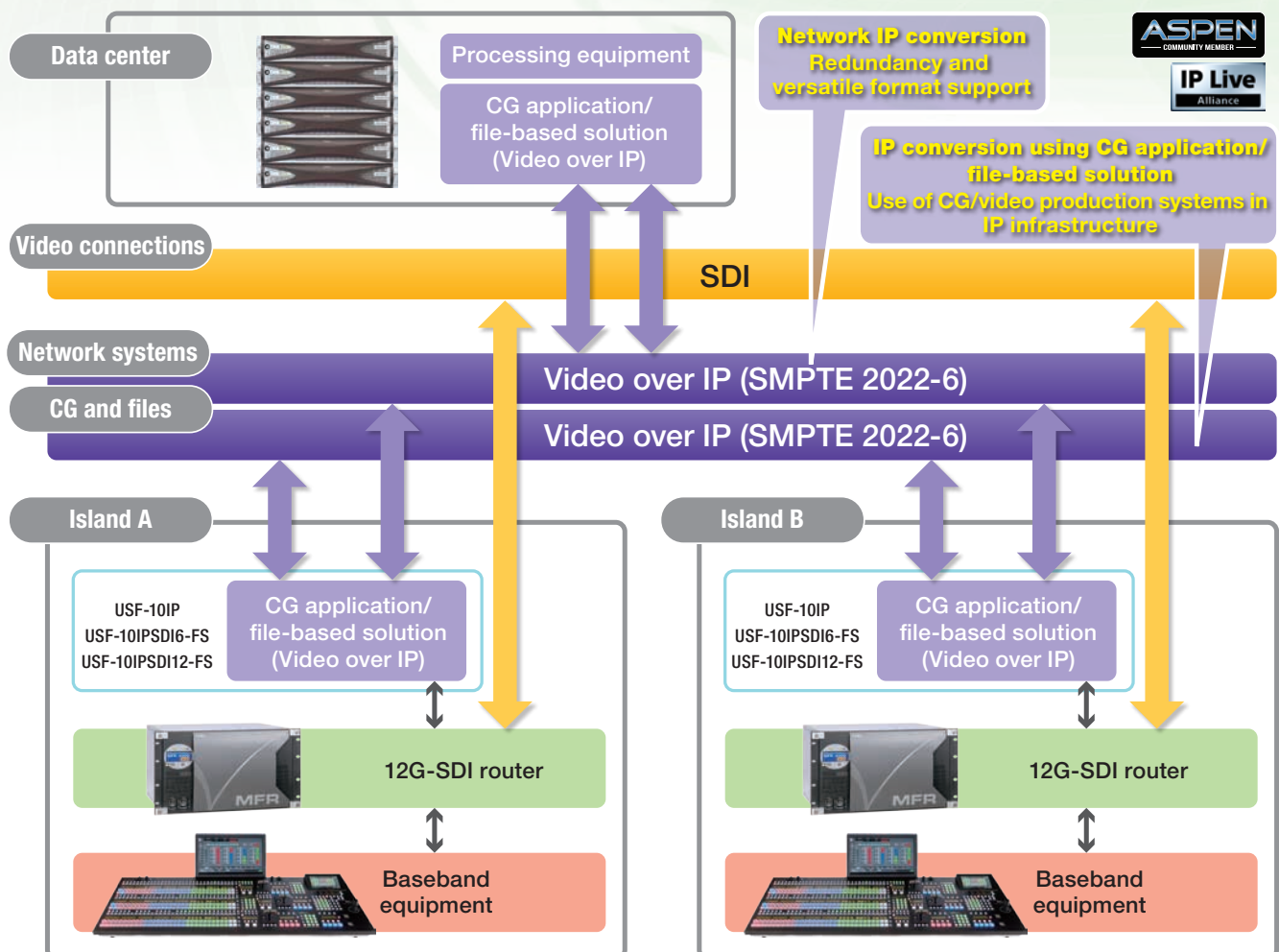

# 10 GbE IP CONVERTER

## Available Modules

### USF-10IP

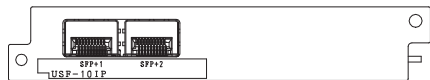

- Dual 10 GbE (SFP+) port
- Converts to other encapsulation modes

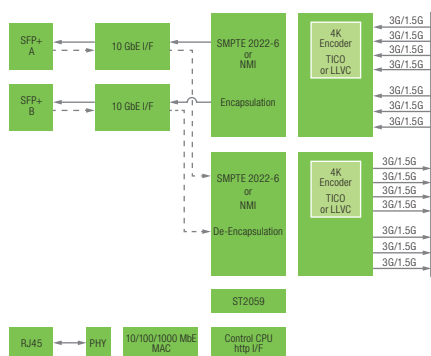

To USF Frame

### USF-10IPSDI6-FS

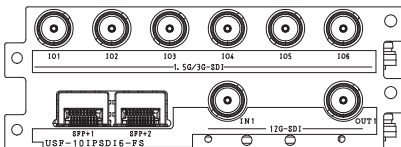

- Dual 10 GbE (SFP+) port
- One 12G-SDI input, one output
- 2SI/SQD conversion, Level-A/B compatible
- SMPT2022-6 (uncompressed): Simultaneous conversion of up to 6 inputs and 6 outputs (6 streams)

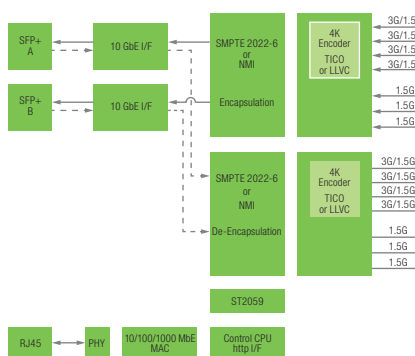

To USF Frame

### USF-10IPSDI12-FS

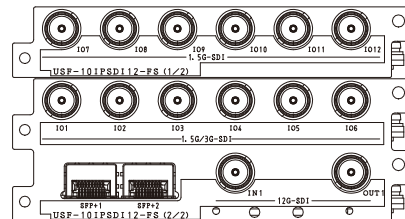

- Dual 10 GbE (SFP+) port
- One 12G-SDI input, one output
- 2SI/SQD conversion, Level-A/B compatible
- SMPT2022-6 (uncompressed): Simultaneous conversion of up to 6 inputs and 6 outputs (12 streams)

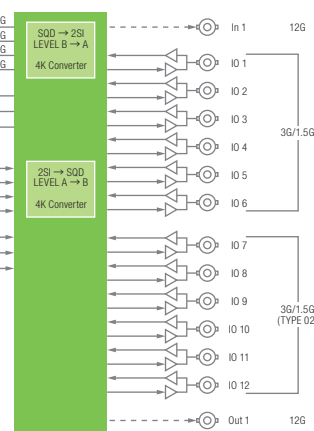

## Specifications (Preliminary)

		USF-10IP	USF-10IPSDI6-FS	USF-10IPSDI12-FS
Video input	SFP+	2 channels	2 channels	2 channels
	SDI	—	12G/3G/1.5G-SDI: 12/3/1.5 Gbps, BNC x 1 (Level-A/B*) 3G/1.5G-SDI: 3/1.5 Gbps, BNC x 6 (Level-A/B*) Signal format*: 2SI or SQD	12G/3G/1.5G-SDI: 12/3/1.5 Gbps, BNC x 1 (Level-A/B*) 3G/1.5G-SDI: 3/1.5 Gbps, BNC x 12 (Level-A/B*) Signal format*: 2SI or SQD
Video output	SFP+	2 channels	2 channels	2 channels
	SDI	—	12G/3G/1.5G-SDI: 12/3/1.5 Gbps, BNC x 1 (Level-A/B*) 3G/1.5G-SDI: 3/1.5 Gbps, BNC x 6 (Level-A/B*) Signal format*: 2SI or SQD	12G/3G/1.5G-SDI: 12/3/1.5 Gbps, BNC x 1 (Level-A/B*) 3G/1.5G-SDI: 3/1.5 Gbps, BNC x 12 (Level-A/B*) Signal format*: 2SI or SQD
IP format		SMPT2022-5/6/7, VSF TR-04, VSF TR-03, ASPEN, NMI		

\* When using 3G-SDI



Head Office: 3-8-1 Ebisu, Shibuya-ku, Tokyo 150-0013, Japan

**FOR-A Corporation of America Corporate Office:** Tel: +1-714-894-3311

11155 Knott Ave., Suite G&H, Cypress, CA 90630, U.S.A.

**FOR-A Corporation of America Northeast Office:** Tel: +1-201-944-1120

2 Executive Drive, Suite 670, Fort Lee Executive Park, Fort Lee, NJ 07024, U.S.A.

**FOR-A Corporation of America Southeast Office:** Tel: +1-305-931-1700

8333 North West 53rd Street, Suite 450, Doral, FL 33166, U.S.A.

**FOR-A Corporation of America Service Center:** Tel: +1-352-371-1505

2400 N.E. Waldo Road, Gainesville, FL 32609, U.S.A.

**FOR-A Corporation of Canada:** Tel: +1-416-977-0343

1131A, Leslie Street #209, Toronto, Ontario, M3C 3L8, CANADA

**FOR-A Europe S.r.l.:** Tel: +39-039-879-778

Via Volturmo, 37, 20861 Brugherio MB, Italy

**FOR-A UK Limited:** Tel: +44-(0)20-3044-2935

Trident Court, 1 Oakcroft Road, Chessington, KT9 1BD, UK

**FOR-A Italia S.r.l.:**

Via Volturmo, 37, 20861, Brugherio MB, Italy

**FOR-A Corporation of Korea:**

1007, 57-5, Yangsan-ro, Yeongdeungpo-gu, Seoul 150-103, Korea

**FOR-A China Limited:**

1307 Huateng Building, No. 302, 3 District, Jinsong, Chaoyang, Beijing 100021, China

**FOR-A Middle East-Africa Office:**

Dubai Media City, Aurora Tower, Office 1407, P.O. Box 502688, Dubai, UAE

**Agiv (India) Private Limited (FOR-A India):**

2nd Floor, Valecha Chambers, Link Road, Andheri (W), Mumbai 400053, India

**FOR-A South East Asia Office:**

Studio 09, Rm. A1, 3/F., Phase 1, Hang Fung Ind. Bldg., 2G Hok Yuen St., Hung Hom, Hong Kong

ISO 9001 and 14001 certified (Sakura R&D)

<http://www.for-a.com/>

Tel: +39-039-881-086/103

Tel: +82-(0)2-2637-0761

Tel: +86-(0)10-8721-6023

Tel: +971-(0)4-551-5830

Tel: +91-22-2673-3623

Tel: +852-2110-1352